

ALUCOBOND®

FAÇADE FASCINATION

Building skins.

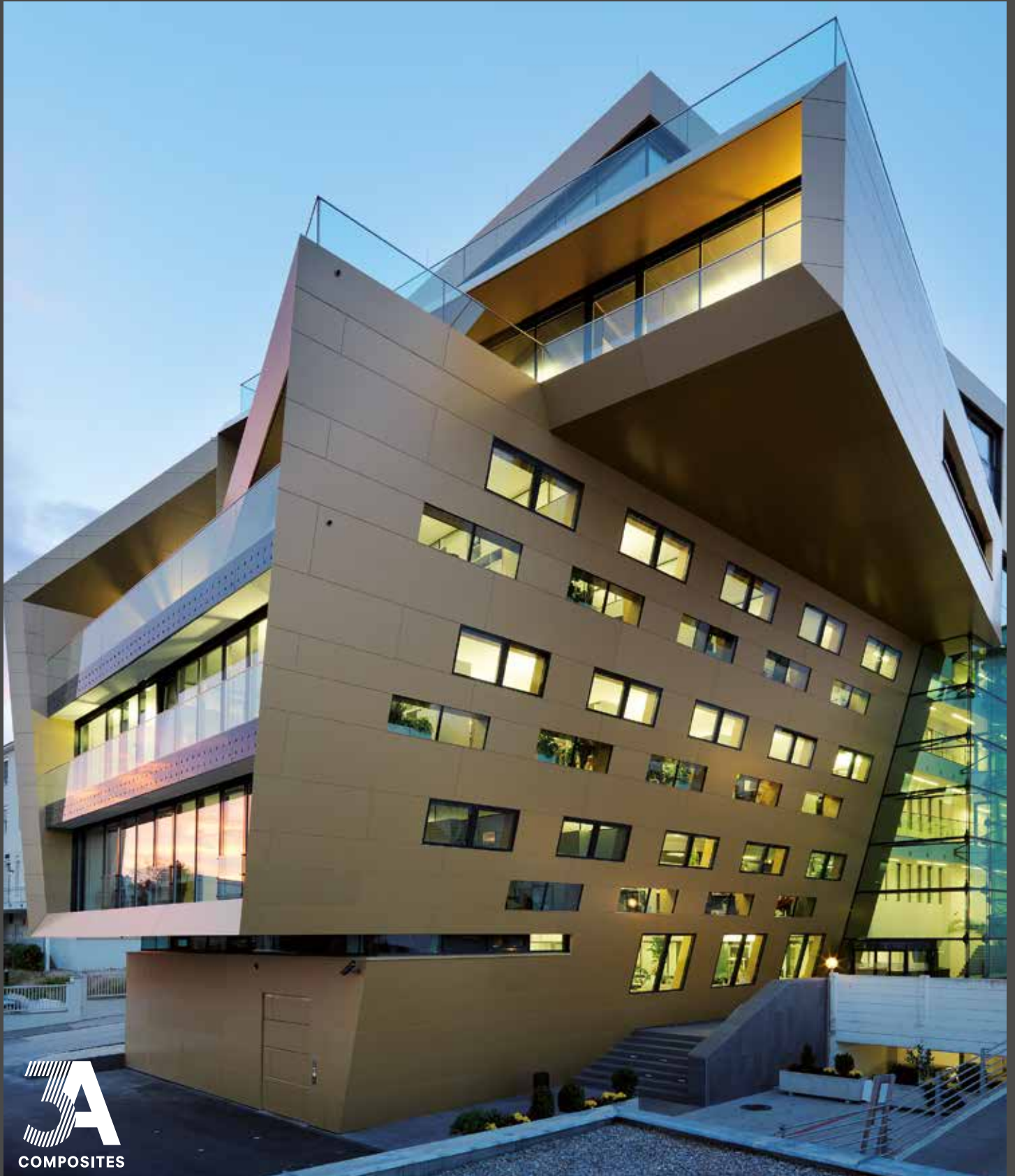



CUSTOMISED SOLUTIONS FOR INDIVIDUAL FAÇADES.

The “skin of the architecture” is a core topic of modern construction. Building envelopes therefore deserve particular attention. They can be simple and functional, exciting and representative. The proportion, materials, surface structure and colouring of façades lead to the creation of unique structures, the balanced and qualitative interplay of which characterise the building culture.

Based on our long years of experience, we regard ourselves as specialists in rear-ventilated aluminium composite façades.

We are happy to share our know-how with customers and offer comprehensive advice from the initial planning phase of any construction project onwards.

S. Amrein-Herche

Sabine Amrein-Herche
Director Marketing & Sales Architecture

ALUCOBOND® THE PRODUCT.

The product. High-quality, resilient and unique in appearance - ALUCOBOND® stands for sustainable construction quality and the highest creative standards. The façade material is distinguished by its outstanding product attributes such as precise flatness, variety of surfaces and colours as well as excellent formability.

ALUCOBOND® for rear-ventilated façades unites the features of energy-efficient construction, economic

viability and architectural quality. The rear-ventilated construction technique is suitable for creating façades on both new and existing buildings as well as roof constructions and interior applications.

The contemporary building types on the following pages feature highly refined envelopes which are not only functional but also emphasise the autonomy and identity of the building. There is usually a clear perception of what constitutes a perfect

building envelope. A long lifespan, easy maintenance and a combination of insulation, ventilation and moisture control are just as important as its aesthetic qualities. ALUCOBOND® provides the best possible conditions for achieving this objective.

CLEAR. DYNAMIC. SYMBOLIC.



An unusual façade and impressive functionality. The building design of the Raiffeisen Finance Centre incorporates statutory building regulations and the differing spatial requirements for each storey in a light-handed way, and develops an uninterrupted exterior which embraces all aspects of bank business. The continuity of the building envelope conveys the company identity

to both employees and customers, while its three-dimensional design ensures its prominence in the cityscape. The façade consists of ALUCOBOND® gold metallic, a colour scheme which conjures up associations with coins or the bank's corporate identity.

The material used in the exterior envelope acts as the starting point for the material design in the interior as well.

The façade is clad in ALUCOBOND®, as are the window reveals and the heat exchanger. The suspended ceilings in the representative areas are made of the same colour metal, meaning the exterior envelope of the building flows on into the interior area.

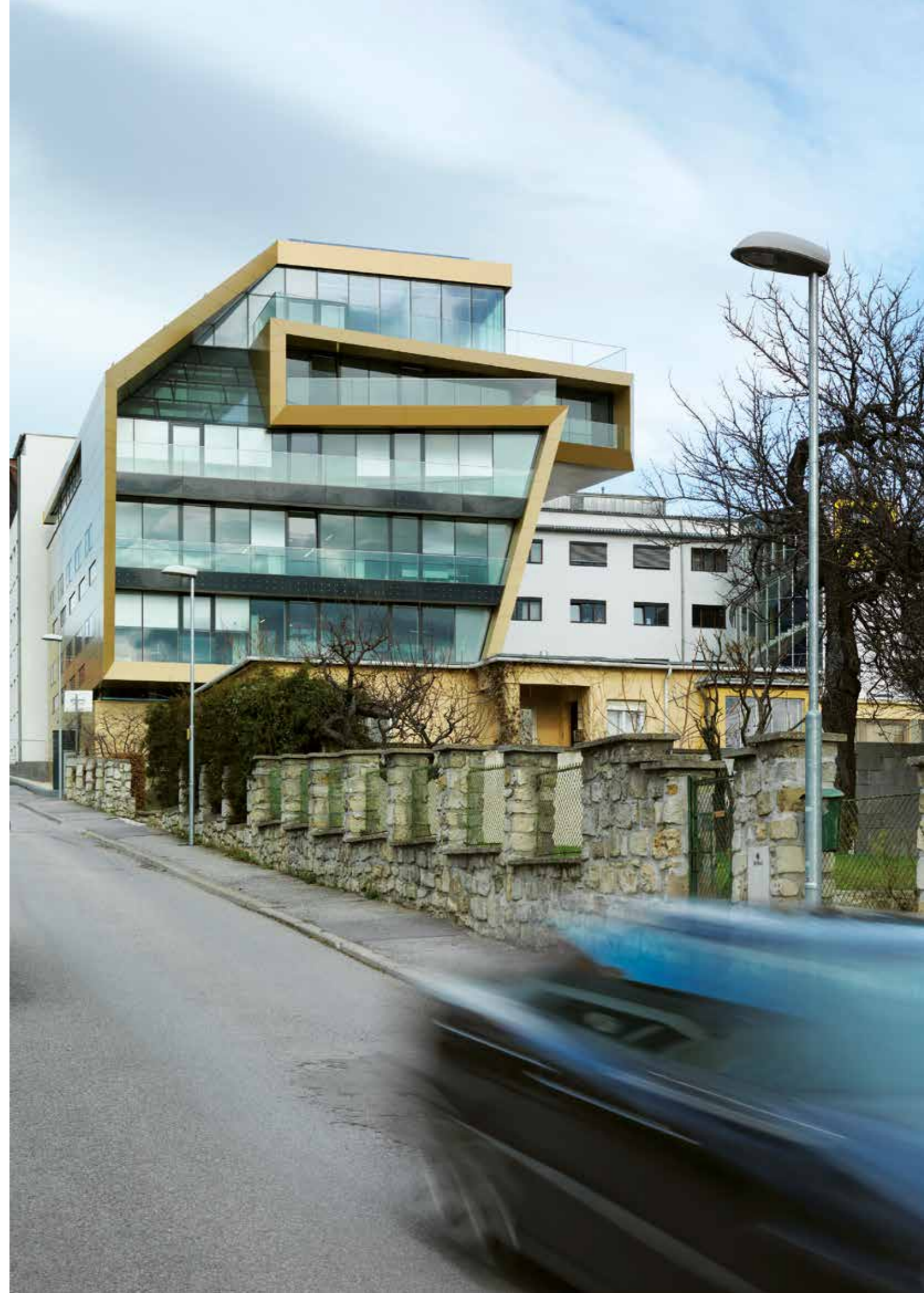



CULTURE, CLADDING, COMMERCE.



Uppsala's landmark concert and congress hall located in the new part of the city, interplays elegantly with its historical surroundings.

A vertical opening in the building caters for public access from two sides - from the old historic city and also from the modern Vaksala Square. The roof of the building provides a spec-

acular view over the city. In the words of Klavs Hom Madsen, Architect and Project Manager with Henning Larsen, Architects "The building interacts with the historic skyline of Uppsala and adds a contemporary chapter to the history of the city".

Uppsala's new concert hall embodies the city's image of this building. "There

are only ten architects in the world like Henning Larsen. His employees select materials and details extremely carefully", explains Gabriel Vikhom, Project Manager of the City of Uppsala. The same applies to the façade. The variation in vertical, slightly curved ALUCOBOND® cassettes in Sunrise Silver Metallic creates the image of a large, split crystal.



Spectacular design, School of Management, Skolkovo, Russia, I David Adjaye Architects, London (Photo: Ed Reeve)

PERFECTION. DOWN TO THE LAST DETAIL.



Clear white architecture set in green surroundings forms the representative platform for Marc Cain fashion. Design, quality and materials of the highest calibre, the latest processing techniques and optimal fit are the watch-words. The architecture embodies the company philosophy and captivates with its clarity and practicality.

The architects Hank and Hirth designed a building that comes across as being linear and classic due to its horizontally structured and clearly legible building elements. Curved elements in white endow the structure with its lightness. The ALUCOBOND® cassettes follow the line of the building very closely. Thanks to the material's particular

formability the design is both bold and sweeping and yet sharp-edged. The matt pure white ALUCOBOND® façade panels reflect day light without shining artificially. Understatement instead of high-gloss, subtle rather than elaborate effects.



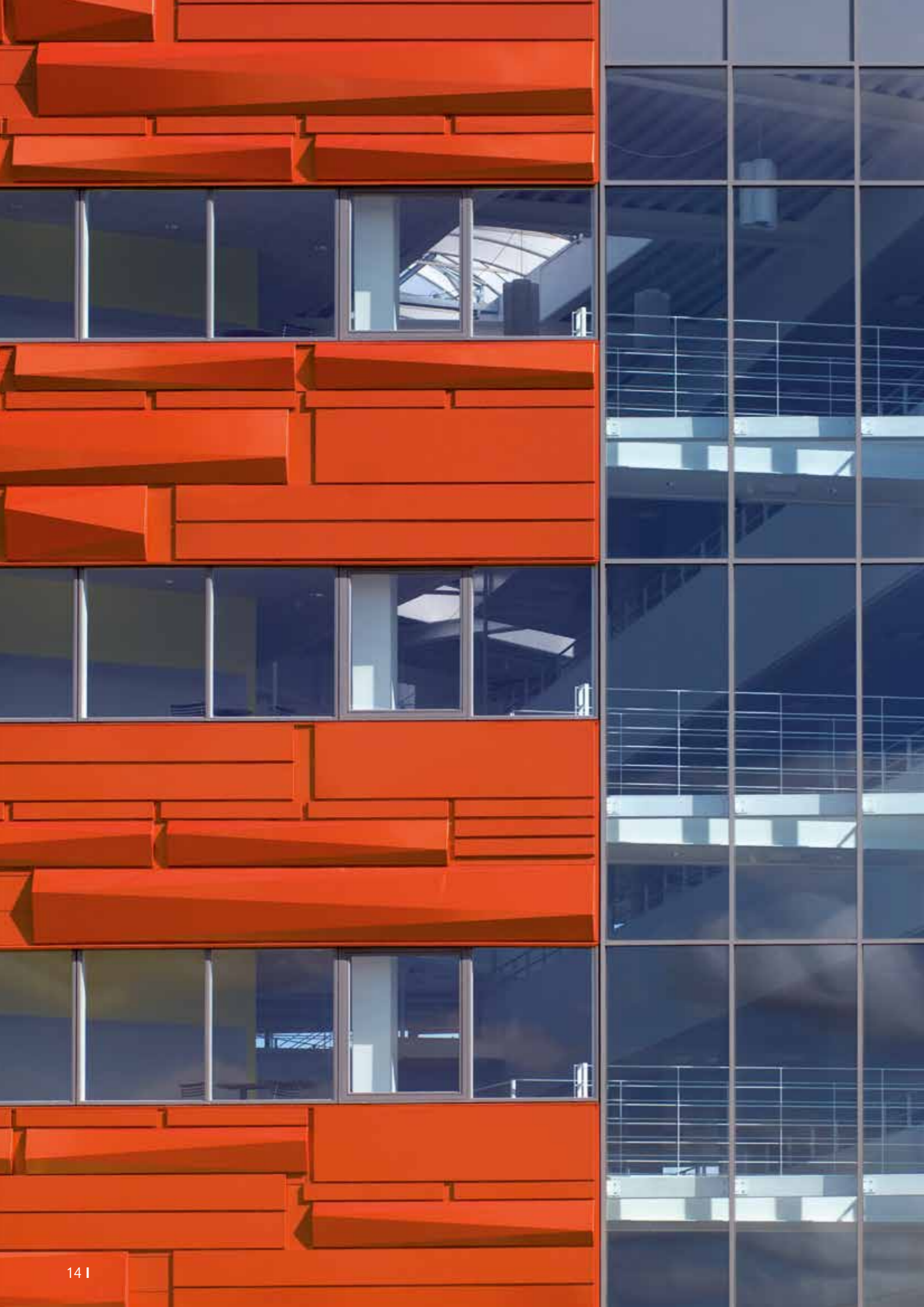

SHAPE MEETS COLOUR.



The Advice House in Lysholt Parken by C. F. Moller, architects from Denmark was the forerunner in a new business district to the north of Vejle. Developed for Lysholt Erhverv A/S, the Advice House, covering a surface area of 5,000 square metres, has an open and flexible layout. The building is formed by two wings set at an angle, which are divided by a

uniform atrium. The building envelope consists of 13 differently shaped elements. The façade structure consists on the one hand of elements with different profile depths which are installed flat, on the other hand, of structured cassettes which are mounted horizontally at staggered intervals.

These shapes underline the special effect produced by ALUCOBOND® spectra Cupral. Depending on the angle of vision and light refraction, the colour reflected changes.



Bus station Hamburg-Poppenbüttel | Blunck + Morgen Architekten, WTM Engineers, Hamburg, Germany



TRUE ELEGANCE.



The office building Onix in Lille, France benefits from its central position. It combines high visibility with good accessibility. Dominique Perrault Architects have designed the building transom, with its variable depth, as “animated, folded and curling up” so as to use the triangular building plot to optimum advantage. The “modulation” of

the body allows for blunt angles for the main entrance and the drive-in entrance to the underground garage, which is located in another structure covered with a “landscaped garden”.

The façade in ALUCOBOND® naturAL LINE is made up of four different modules with changing width, consisting of fixed opaque glass panels

which can be opened as well as fixed and turnable ones. The latter are used mainly in the higher floors while in the lower storeys, the façade is built in a completely transparent manner. On the roof, a metal structure envelopes the technical facilities and emphasises the streamlined shape of the entire structure.

CHECK IN – CHECK OUT.



The 75,000 m² Terminal 2 of Dublin Airport was designed by the London office of Pascall + Watson specifically with the needs of travellers in mind.

The building, which is very appealing to the eye, uses day light to optimum effect to create really bright and airy rooms, which have both a soothing and relaxing effect. Passenger flow concepts played a key role in the design process resulting in clear and logical travel arrangements.

The rounded, flowing shapes of the building were achieved by intelligent use of ALUCOBOND® panels in silver metallic and traffic grey.

Taking the local surroundings into account was also an important decision criterion when selecting the materials for the project.

The building sets new ecological standards by achieving a 17% reduction

in CO₂ emissions in comparison with statutory specifications. Terminal 2 has already been awarded with the Corus Structural “Steel Design Award, 2010” and the “CMB Building Design Award” for the best public building of 2010 by the general public.





BRIGHTLY-COLOURED STUDY.



Large format ALUCOBOND® façade elements in two different silver metallic shades and with red highlights were used to face the existing yellowish-white ceramic wall tiles of the student residence in Dresden, Germany.

While retaining the existing window size and positioning, the team of architects at Zimmermann Architek-

tengemeinschaft created a sculptural, 3-dimensional façade using overlapping scale-like façade panels laid out in a chess board pattern and varying window reveals. The structural effect of light and shadow is highlighted on the one hand by accentuating the reveals and, on the other hand, by the difference in depth between external cladding – and the slightly recessed

window. When walking past, the passer-by is aware of the continuously changing appearance of the building's exterior. According to the angle of vision and the position of the sun, the window reveals, which are in part folded and in part formed in bold red, stand out against the façade with varying degrees of intensity.

THE NEW METZ CATHEDRAL.



Matisse, Picasso, Miró, Pollock and Brancusi have already moved in and can be admired in their own new home. Shidgeru Ban says that in designing the idiosyncratic new construction, he was inspired by the “architecture” of traditional Chinese hats woven from rice straw - albeit on a considerably distorted floor plan. The offices, with their large, smooth

windows, were accommodated in the angular transoms of Centre Pompidou in Metz, and appear to have been pushed into the hat. These white cubes were highlighted by the flatness of the ALUCOBOND® elements in pure white.

The new 10,000- square metre centre for the arts in north eastern France does not exhibit any collection of its

own but makes use of works stored at the Paris centre, which, with more than 65,000 works, owns the largest collection of contemporary and modern art in Europe. For the City of Metz, the new art centre means so much that it can also be described as the “new Metz cathedral”.



ONE MATERIAL FOR EVERY PURPOSE.

Stability of shape

Variety of colours & surfaces
Fire safety

Durability
Flatness
Lightness
Formability

Rigidity

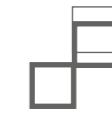

Business, industries, services
OFFICE AND ADMINISTRATIVE BUILDINGS, BANKS, WHOLESALE AND RETAIL, FAIR AND EXHIBITION BUILDINGS, PRODUCTION SITES

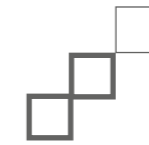

Sport & leisure
FOOTBALL STADIA, SPORTS CENTRES

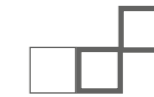

Infrastructure buildings
HARBOURS AND SHIPPING FACILITIES, RAILWAY STATIONS, AIRPORTS, MULTI-STOREY CAR PARKS

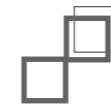

Residential construction
HOUSING DEVELOPMENT, APARTMENT COMPLEX



Academic studies, teaching and research
SCHOOLS, FURTHER EDUCATION, UNIVERSITIES, INSTITUTIONS OF HIGHER EDUCATION, NURSERIES, DAY CARE CENTRES



Public buildings
POLICE, COMMUNITY CENTRES, CIVIC CENTRES, CIVIC HALLS

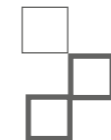

Public health services
HOSPITALS, CLINICS, CONVALESCENT HOMES



Cultural buildings
CONCERT HALLS, THEATRES, CULTURAL CENTRES, MUSEUMS, LIBRARIES



Hotels, restaurants, tourism
HOTELS, ACCOMMODATION PROVIDERS, RESTAURANTS, PUBS

OUR STRENGTH IS IN THE DETAIL.

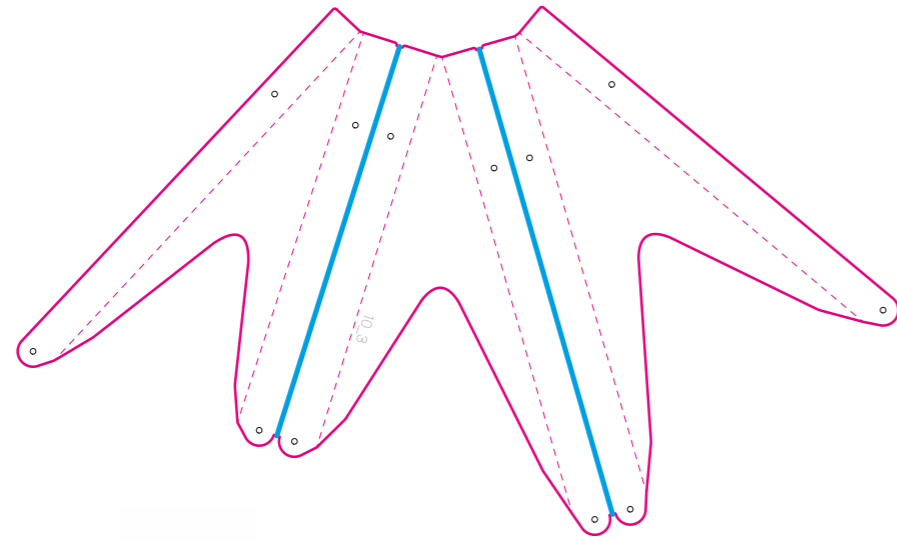

Layer
 180_Degree Width: 12 mm
 90_Degree Width: 3 mm
 Outer Lining
 Inner Lining
 Engraving Width: 1 mm; depth: can be read
 ALUCOBOND® material:
 4mm all millings run on the back

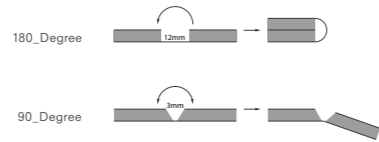

“The Swarm” is a parametrically designed, free-standing, sculptural pavilion. It was developed by students at the Institute for Emerging Technologies at the Munich Technical University based on the theme of a flock of birds on the wing. Amassing 211 individual CNC-milled ALUCOBOND® modules creates an interplay between density, light and shadow. The material was made available to the students within

the framework of cooperation between 3A Composites and the Technical University Munich.

The individual shaping and moulding can be attributed to the particularly high-level of ALUCOBOND® formability. By using a combination of milling techniques, panels can be folded adeptly and turned into a three-dimensional structurally effect form.

Angularity and filigree forms are possible due to the material’s minimal bend radius.

ALUCOBOND® aluminium composite panels feature optimum formability, outstanding surface quality and extreme flatness ensuring that your architecture as well gets a unique look.

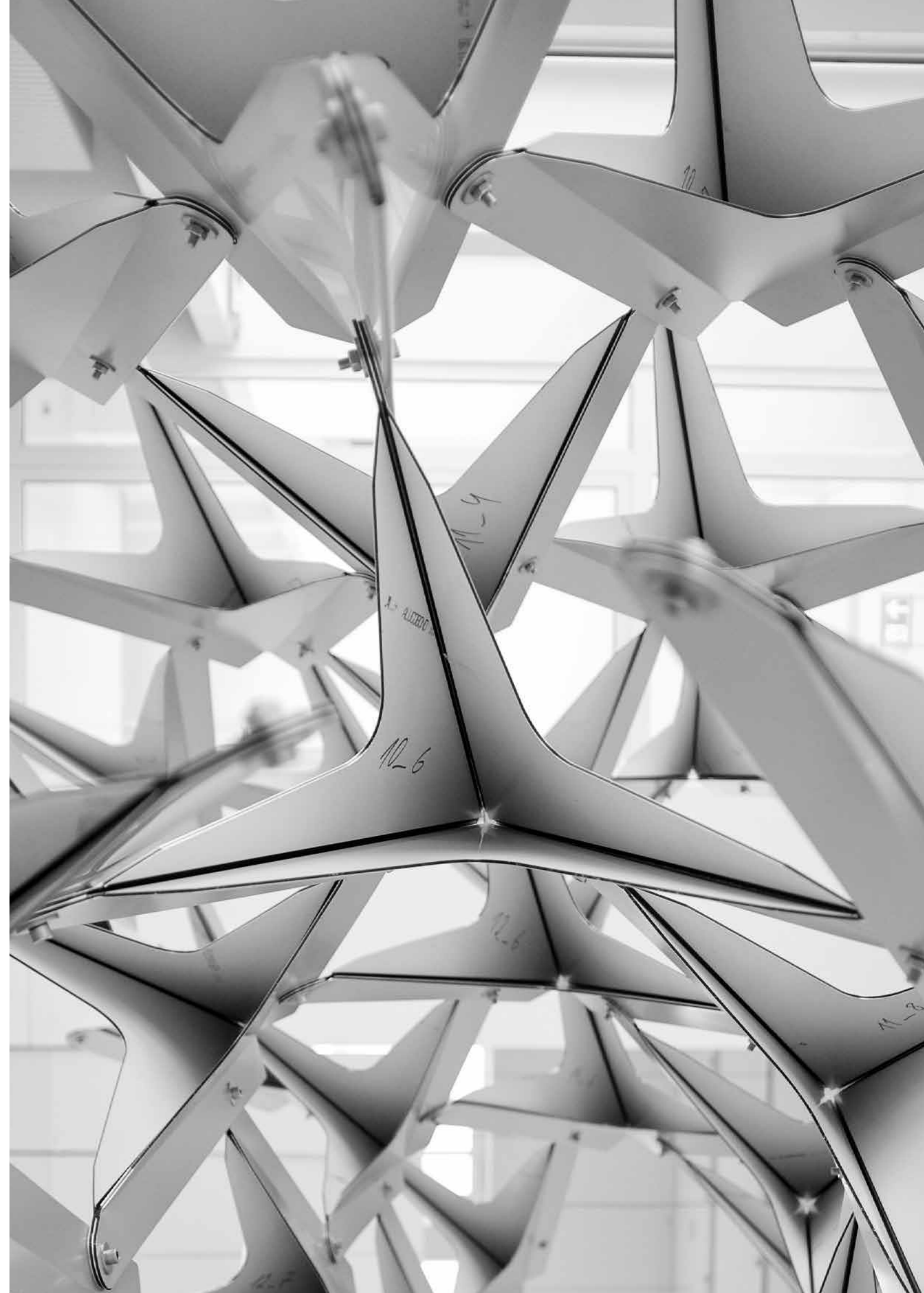

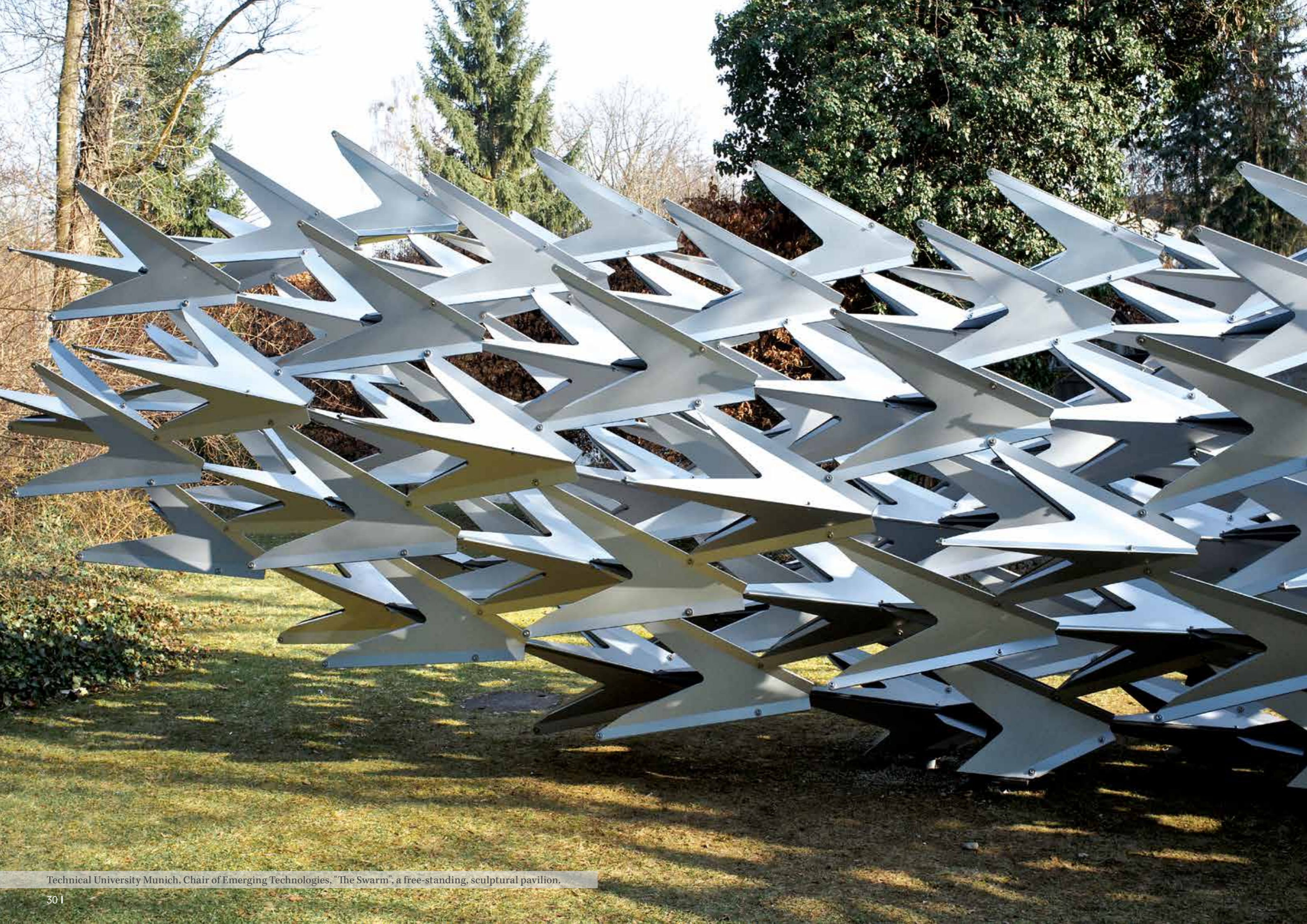

Technical University Munich, Chair of Emerging Technologies, "The Swarm", a free-standing, sculptural pavilion.

AN INSPIRING RANGE OF COLOURS AND SURFACES.

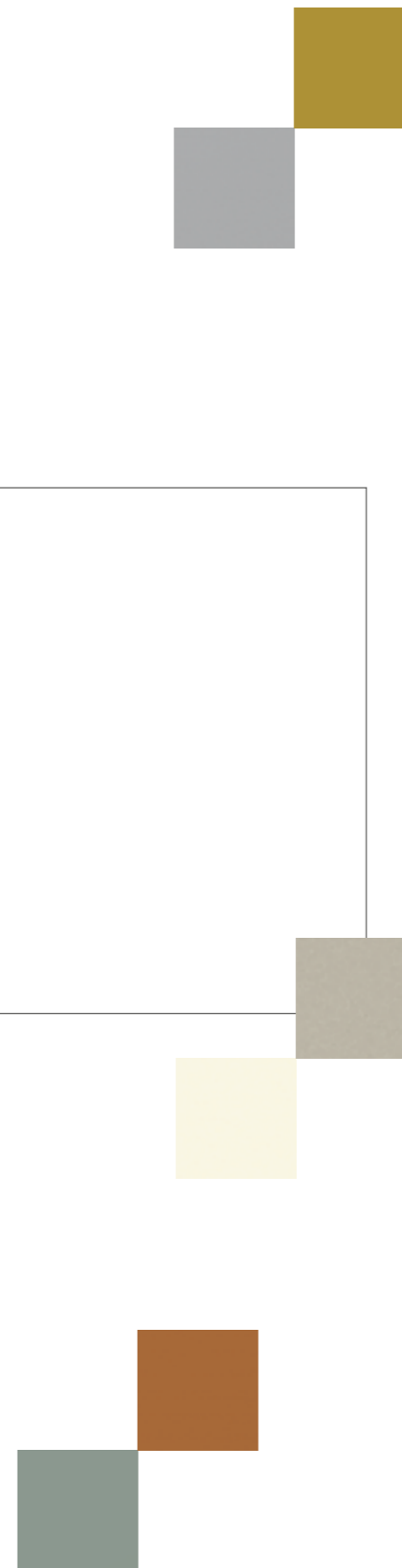
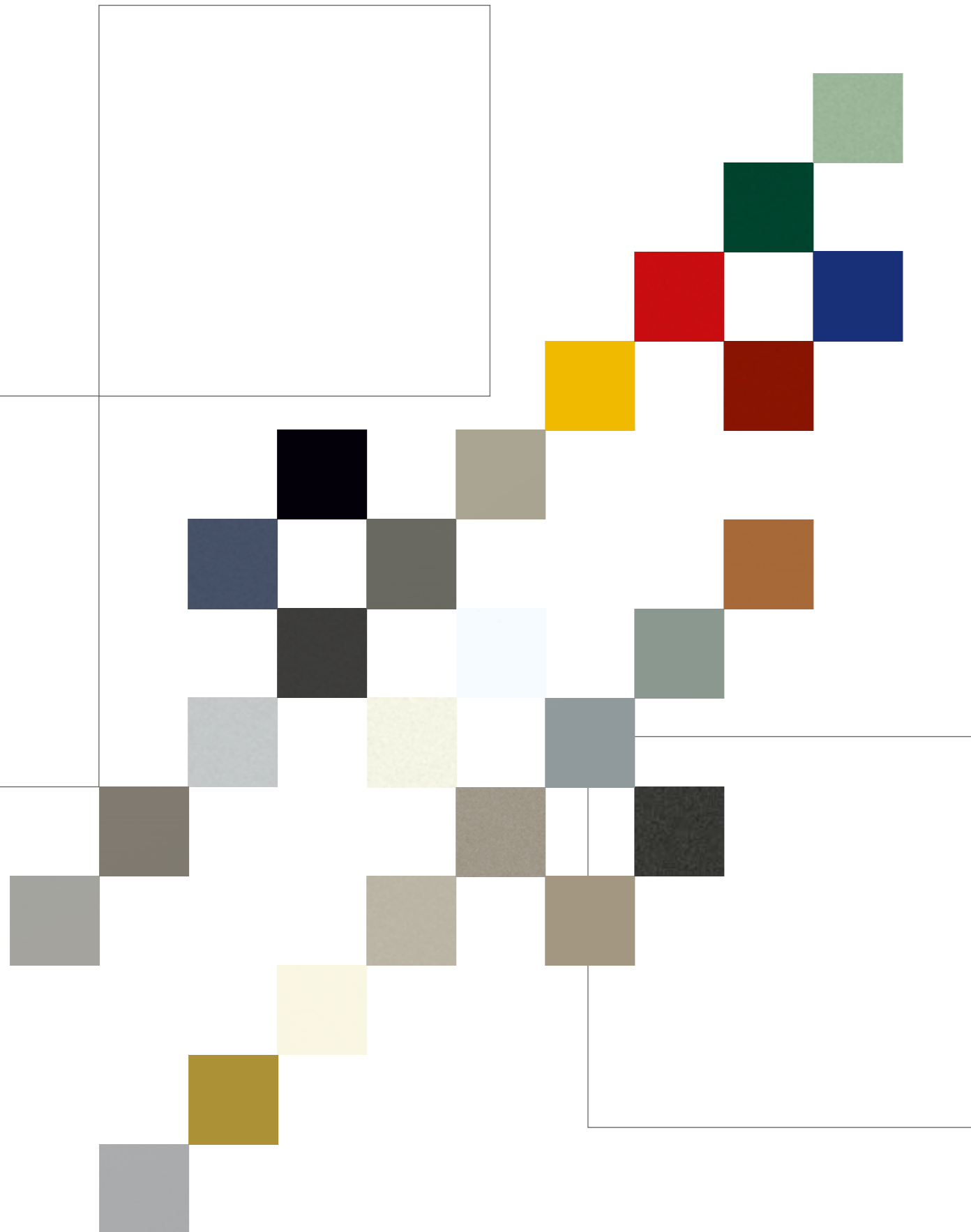

The effect of space is created by colour and light. As an essential component of architecture, a colour scheme creates individual space and plays an essential supporting role in the utilisation of the building.

ALUCOBOND® solid colours
From delicate white to strong red: solid colours generate a unified appearance without any special effects.

ALUCOBOND® metallic colours
Changing light conditions and perspectives endow these timelessly elegant colours with a glowing, lively appearance.

ALUCOBOND® spectra & sparkling colours
Depending on the type of pigment and angle of vision, a particularly eye-catching effect is created by the changing colour gradients of the spectra colours with iridescent highlights. Subtle glitter and shine effects make sparkling colours so exciting.

ALUCOBOND® anodized look
Matt finish, velvet-like metal has a charm all of its own. Made in accordance with the EURAS industrial standard, the surfaces harmonise optimally with anodised window frames, profiles and doors. In contrast to anodised materials, ALUCOBOND® anodized look panels can be trimmed and bent without any problem.

ALUCOBOND® naturAL
Aluminium's natural and original beauty is shown to its best effect and every object takes on a distinguished yet lively appearance. The surface structures bring about an interplay between metallic shine and the reflection and absorption of light. In addition, a refined metallic look is created by the subtle rapprochement to real metals.

ALUCOBOND® legno
The natural beauty of wood united with the strength of ALUCOBOND®: outstanding formability, excellent flatness and bending stiffness as well as excellent long-term durability and weather resistance. Moreover, a special coating adds a grainy structured feel to the surface.

ALUCOBOND® urban
Urban life is characterised by interplays of light and shadows, transparency and colour. Muted, extremely mat surfaces and colours of ALUCOBOND® urban provide open space for design and support the urban character of the building.

ALUCOBOND® terra
Stone and crystal stand for endurance, authenticity and intrinsic value. They reflect light in a magical, vibrant way and their texture is unexpectedly varied: ranging from rough to smooth. ALUCOBOND® terra is inspired by iridescent stone. The décor's surface refracts the daylight creating a matt sheen and lustrous hues, sometimes elegant and sometimes earthy.

ALUCOBOND® vintage
"Concrete" free of moss growth, "rusty steel" which does not bleed, "copper with a patina" but no rust marks when it rains or "oxidised metal" without creeping corrosion – the matt surfaces of ALUCOBOND® vintage hold back time: halting the weathering processes which are typical for these materials and preserving the chosen design.

SURFACE QUALITY FOR DURABILITY AND COST-EFFECTIVENESS.

UV-RESISTANT COATING

The basic pre-conditions for sustainable façades are durable surfaces. That is why we coat our aluminium using the continuous “coil coating” procedure. This procedure allows the highest quality paint to be applied economically.

All colours are applied in several coats and stove lacquered. This ensures a durable, brilliant colour effect.

For high quality architecture for external applications, we use high quality polymer paint systems such as PVDF (polyvinyl fluoride) and FEVE (Fluoroethylene-Alkyl Vinyl Ether), which have proven to be optimal for surface use in architecture.

LONG-TERM PAINT QUALITY

The assessment of the various paint qualities is undertaken in external weathering tests according to the following parameters:

1. durability of the paint particles
2. durability of the level of gloss
3. chalking behaviour

Our ALUCOBOND® quality benchmarks lie far above the usual E.C.C.A test requirement.

CLEANING

The PVDF coating comprises a highly cross-linked surface which means dirt retention on the surface is minimal. Slight soiling can be washed off in an environmentally friendly manner using warm water and, if applicable, a neutral cleaning agent. Graffiti can usually be removed by using special cleaning agents.

45° S. Florida
 PVDF Polyester
 Siliconized polyester Aqueous acrylic
 Vinyl Solvent acrylic

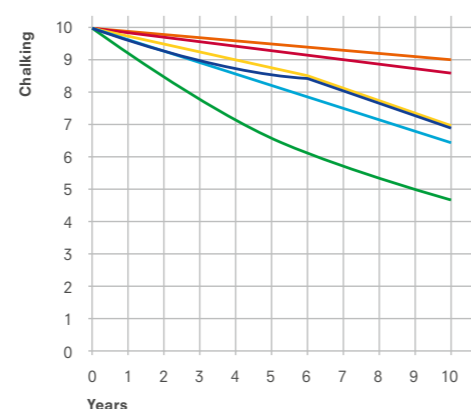
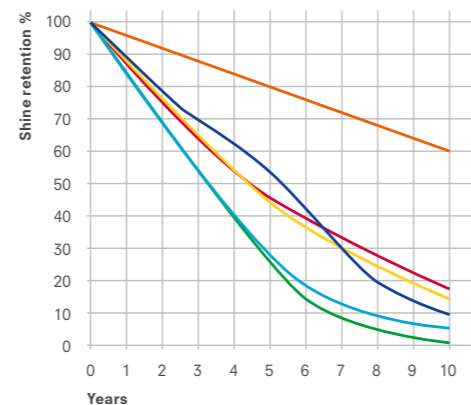
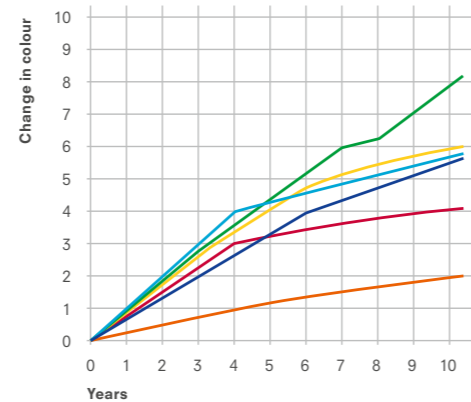

FLEXURAL RIGIDITY AND RESILIENCE.

FLEXURAL RIGIDITY

Aluminium cover sheets and a mineral core ensure an impressive weight: flexural rigidity relation, even in terms of large panel sizes. Despite the easy and lightweight handling which this brings about when processing and assembling, ALUCOBOND® consistently shows its strong side, due to its excellent flexural rigidity: the panel remains stable in terms of shape and flatness, even when there are extreme temperature fluctuations.

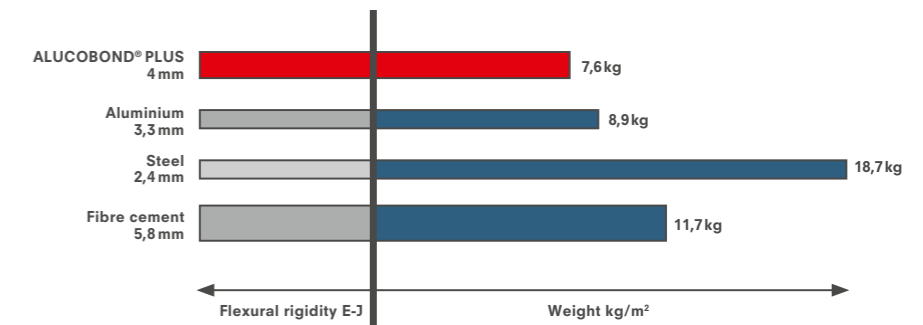

Comparison of thickness and weight with the same flexural rigidity

LOADING AND PANEL DIMENSIONS

This chart is to determine the maximum panel size of ALUCOBOND® panels supported on all 4-sides based on the characteristic stress of 90 N/mm² (without safety).

Please inquire the design values also for other systems and panel thickness.

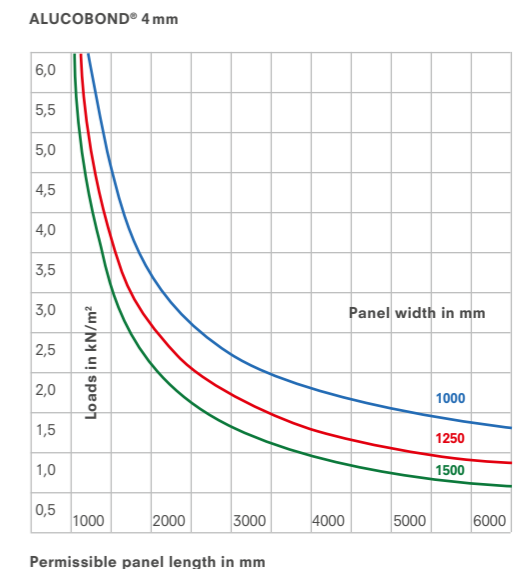

MATERIAL PROPERTIES.

ALUCOBOND® PLUS

ALUCOBOND® PLUS has been developed exclusively for the more stringent requirements of the fire prevention regulations in architectural products. Thanks to its mineral-filled, core ALUCOBOND® PLUS meets the stricter requirements of the fire classifications. It is hardly inflammable and offers all the proven product properties of the ALUCOBOND® family, such as flatness, formability, resistance to weather and easy processing.

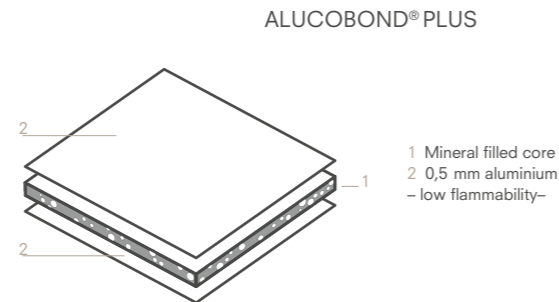

ALUCOBOND® A2

ALUCOBOND® A2 is the only non-combustible aluminium composite panel used in architecture that fulfills the respective standards worldwide. Thanks to its mineral-filled core, ALUCOBOND® A2 meets the strict requirements of the fire regulations and enhances the possibilities for the concept and design of buildings. ALUCOBOND® A2, just like all the products of the ALUCOBOND® family, allows simple processing, is impact-resistant, break-proof and weatherproof and, above all, non-combustible.

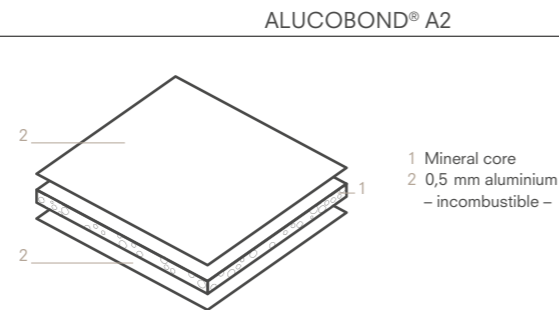

PRODUCT RANGE.

ALUCOBOND® PLUS

Thickness: 3/4 mm (6 mm on request)

Width [mm]	1000	1250	1500	1575	1750
Length [mm]	2000 – 6800	2000 – 6800	2000 – 6800	2000 – 6800	2000 – 6800
Solid & Metallic colours	●	●	●	●	○
Spectra & sparkling colours	●	●	●	●	--
Anodized Look	●	●	●	○	○
NaturAL	--	●	○	--	--
ALUCOBOND® legno – premium wood	○	●	●	--	--
Vintage	○	●	●	--	--
Façade design – Individualdekor	○	●	●	--	--
Urban	○	●	●	--	--
Terra	○	●	●	--	--
Wood	○	○	●	○	--
Anodised*	--	●	○	--	--
Matt finished	●	●	●	--	--

○ On request

ALUCOBOND® A2

Thickness: 3/4 mm

Width [mm]	1000	1250	1500	1575	1750
Length [mm]	2000 – 6800	2000 – 6800	2000 – 6800	2000 – 6800	2000 – 6800
Solid & Metallic colours	--	●	●	--	○
Spectra & sparkling colours	--	●	●	--	--
Anodized Look	--	●	●	--	○
NaturAL**	--	●	○	--	--
ALUCOBOND® legno – premium wood	--	●	●	--	--
Vintage	--	●	●	--	--
Façade design – Individualdekor	--	●	●	--	--
Urban	--	●	●	--	--
Terra	--	○	○	--	--
Wood	--	○	○	--	--
Mill-finished	--	●	●	--	--

○ On request

The delivery time and minimum quantity vary according to size and thicknesses. Other dimensions are available on request.

MASS TOLERANCES (STANDARD)

Due to manufacturing, a displacement of the cover sheets sidewise at the panel edges up to 2 mm is possible.
 Thickness: ± 0.2 mm (matt finish | stove enamelled | anodised)
 Width: - 0 / + 4 mm
 Lengths: 2000 – 4000 mm; - 0 / + 6mm
 Lengths: 4001 – 6700 mm; - 0 / + 10mm

COLOURS AND SURFACES

Further colours and surfaces are available upon request.

* Anodized according to DIN 17611. All anodized ALUCOBOND® composite panels have contact lines (about 25mm width) on their short sides. For panel lengths of more than 3500mm, the composite panels have contact lines (about 20mm width) on their long sides. On the back, there are contact lines of about 35mm on the short and the long sides of the panels. Maximum panel length 6500mm. Please take this into consideration when dimensioning the panels.

** Exception: ALUCOBOND® naturAL Reflect is only available in ALUCOBOND® PLUS.

TECHNICAL DATA.

Technical data	ALUCOBOND® PLUS				ALUCOBOND® A2	
	Standard	Unit	3mm	4mm	3mm	4mm
Thickness						
Cover sheet thickness	t	mm	0,5		0,5	
Weight	G	kg/m ²	5,9	7,6	5,9	7,6

Technological values							
		Standard	Unit	ALUCOBOND® PLUS		ALUCOBOND® A2	
Section modulus	W	DIN 53293	cm ³ /m	1,25	1,75	1,25	1,75
Rigidity	E·J	DIN 53293	kNcm ² /m	1250	2400	1250	2400
Alloy		EN 573-3		EN AW 5005A (AlMg1)			
Temper of cover sheets		EN 515		H22/H42			
Modulus of elasticity	E	EN 1999 1-1	N/mm ²	70000			
Tensile strength of cover sheets	R _m	EN 485-2	N/mm ²	≥ 130			
Proof stress (0,2%)	R _{p0.2}	EN 485-2	N/mm ²	≥ 90			
Elongation	A ₉₀	EN 485-2	%	≥ 5			
Linear thermal expansion	α _t	EN 1999 1-1		2.4mm/m with 100°C difference in temperature			

Acoustical properties							
		Standard	Unit	ALUCOBOND® PLUS		ALUCOBOND® A2	
Sound absorption factor	α _s	ISO 354		0,05		0,05	
Sound transmission loss	R _w	ISO 717-1	dB	≥25		≥25	
Loss factor	d	EN ISO 6721		--	--	0,004	0,005

Thermal properties							
		Standard	Unit	ALUCOBOND® PLUS		ALUCOBOND® A2	
Thermal resistance	R	DIN 52612	m ² K / W	0,007	0,009	0,002	0,002
Thermal conductivity	λ	DIN 4108	W/m K	0,49	0,44	1,99	1,77
Heat transition coefficient	U	DIN 4108	W/m ² K	5,68	5,58	5,83	5,80
Temperature resistance			°C	-50 to + 80			

APPROVALS.

Country	Authorisation	Name	Authorising body
Belgium	ATG 12/2368	ALUCOBOND® Cassettes; Bardage rapporté	UBATc, Brussels
Czech Republic	c.216/C5a/2013/0022	ALUCOBOND®	PAVUS a.s., Prague
France	n° 2/09-1372 n° 2/09-1371	ALUCOBOND® Riveté ALUCOBOND® Cassettes	CSTB, Paris CSTB, Paris
Germany	Z-10.3-774	ALUCOBOND® Façade system	DIBt, Berlin
Great Britain	No 05/4214	ALUCOBOND® Cladding System	British Board of Agrément (BBA), Garston
Poland	AT-15-4058	ALUCOBOND®	Instytut Techniki Budowlanej, Warsaw
Russia	TC 3750-13	ALUCOBOND® Panels and cassettes elements	ФЛЦ, Moscow
Singapore	011937	Product listing scheme: class 2	PSB Singapore
Slovakia	TO-06/0275	ALUCOBOND®	TSUS, Bratislava
Spain	No 345 No 346	Sistema de revestimiento de fachadas ventiladas mediante bandejas procedentes de paneles ALUCOBOND® Sistema de revestimiento de fachadas ventiladas mediante bandejas procedentes de paneles ALUCOBOND®	Instituto Eduardo Torroja, Madrid Instituto Eduardo Torroja, Madrid



FIRE CLASSIFICATION.

Country	ALUCOBOND® PLUS		ALUCOBOND® A2	
	Tested according to...	Classification	Tested according to...	Classification
EU	EN 13501-1	Class B, s1, d0	EN 13501-1	Class A2, s1, d0
Germany	EN 1187 (Methode 1) / DIN 4102-7	fulfilled	EN 1187 (Methode1)/ DIN 4102-7	fulfilled
Great Britain England / Wales / Scotland	met the performance criteria of BR 135	Class B-s1, d0	met the performance criteria of BR 135	meets requirements of LUL limited combustible non combustible
Switzerland	VKF	Utilisation RF2	VKF	Utilisation RF1
Poland	PN-90/B-02867	NRO	EN 13501-1	Class A2, s1, d0
Russia	GOST 30244-94 GOST 30402-95 GOST 12.1.044-89 GOST 12.1.044-89	G1 (combustibility) W1 (flammability) D2 (smoke development) T1 (smoke flammability)	GOST 30244-94 GOST 30402-95 GOST 12.1.044-89 GOST 12.1.044-89 GOST 31251-03	G1 (combustibility) W1 (flammability) D1 (smoke development) T1 (smoke flammability) k0
Australia	AS ISO 9705 AS 1530.3 Indices EN 13501-1	Group 1 material SMOGRA 1.385 m2 / s2 0 (flammability) 0 (spread of flames) 0 (thermal development) 0 - 1 (smoke development) B, s1, d0	AS ISO 9705 AS 1530.3 Indices EN 13501-1	Group 1 material SMOGRA 0.630 m2 / s2 0 (flammability) 0 (spread of flames) 0 (thermal development) 0 - 1 (smoke development) A2, s1, d0

	Large fire testing	Classification	Large fire testing	Classification
Austria	ÖNORM B 3800-5	passed	ÖNORM B 3800-5	passed
Hungary	MSZ 14800-6	passed	MSZ 14800-6	passed
Great Britain	BS 8414 part 1 & 2	passed	BS 8414 part 1 & 2	passed
Russia	GOST 31251	passed	GOST 31251	passed

FIXING METHODS.

You will find below documentation of the most up to date construction drawings with corresponding images showing usage. You can also contact us directly for individual questions relating to matters of application technology. Our technical team of experts will be happy to assist you in realising your projects.

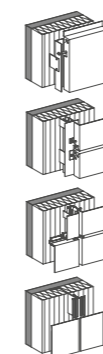

- Cassette mounted** on stainless steel bolts for vertical façade structuring
- Cassette screwed** on vertical façade structuring
- Cassette SZ20** tongue and groove principle for horizontal façade structuring
- Glued** for vertical/horizontal façade structuring

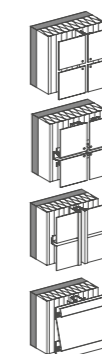

- Riveted/screwed** onto vertical supporting beams for vertical façade structuring
- Riveted** onto omega profiles for vertical installation.
- Clamped/screwed** onto double hat profiles
- Riveted weather boarding** on aluminium sub-construction

FIXING SYSTEMS.

CONCERT & CONGRESS HALL, UPPSALA, SWEDEN
Henning Larsen Architects, Denmark

1 CASSETTE mounted on stainless steel bolts for vertical façade structuring.

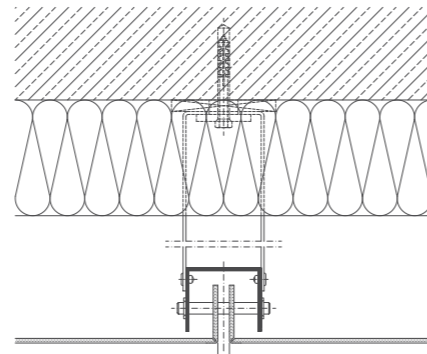
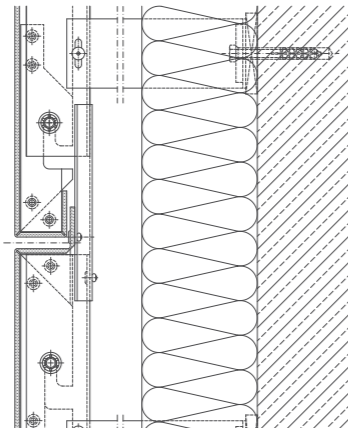
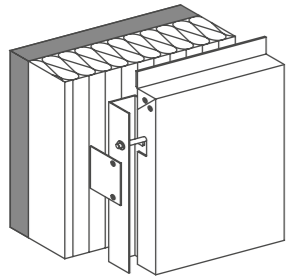

S. OLIVER CASINO, GERMANY
Menig & Partner, Rottendorf, Germany

2 CASSETTE SCREWED for vertical façade structuring

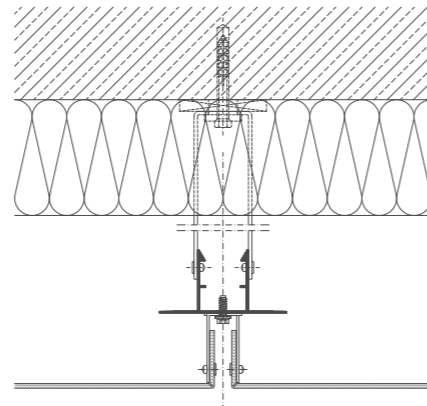
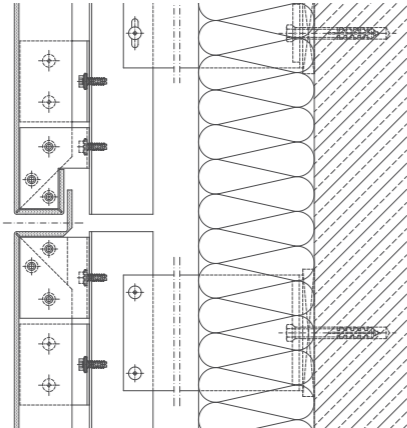
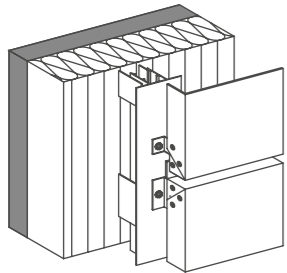

FIXING SYSTEMS.

HEADQUARTERS MARC CAIN, BODELSHAUSEN, GERMANY
 Hank + Hirth, Ehningen, Germany

3 CASSETTE SZ20
 tongue and groove principle horizontal
 façade structuring.

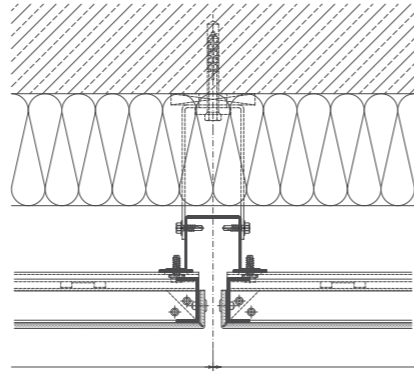
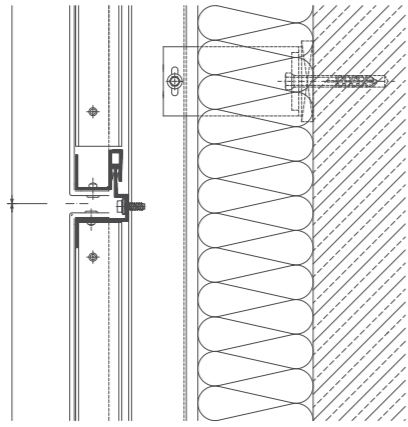
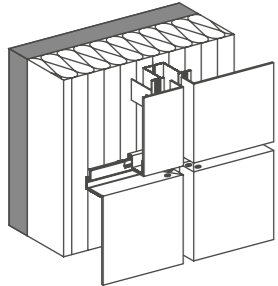

IMF TERTIA GMBH, LANNACH, AUSTRIA
 Hermann Eisenköck Architects, Graz, Austria

4 GLUED
 for vertical / horizontal façade structuring

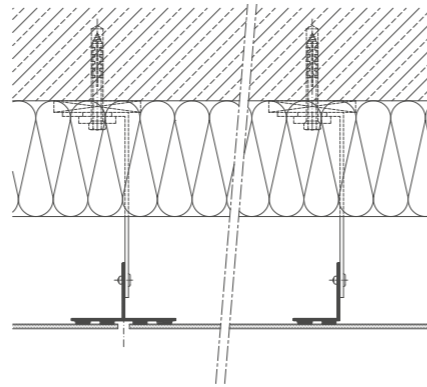
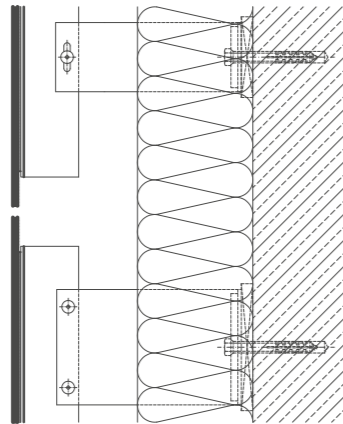
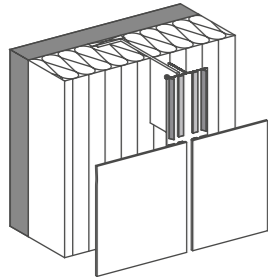

FIXING SYSTEMS.

CRUISE CENTER ALTONA, HAMBURG, GERMANY
Renner Hainke Wirth Architekten, Germany

5 RIVETED/SCREWED
onto vertical supporting beams for vertical façade structuring

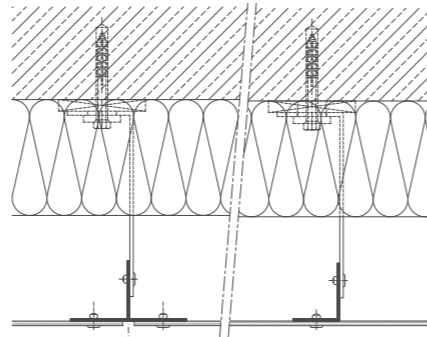
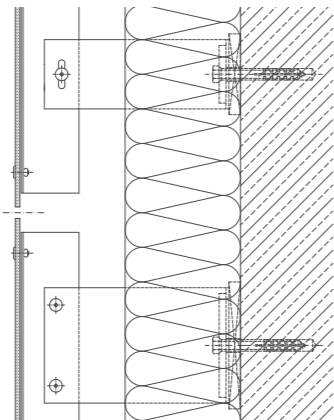
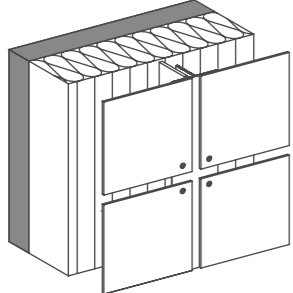

HÖXTERSTRASSE, HAGEN, GERMANY
Stadtbildplanung Dortmund, Germany

6 RIVETED/SCREWED
onto omega profiles for vertical installation

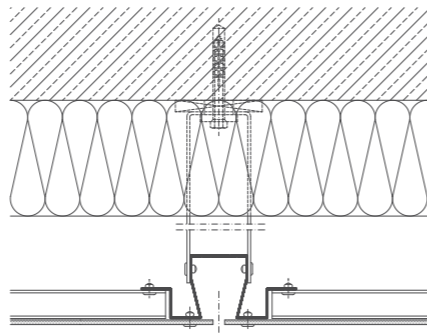
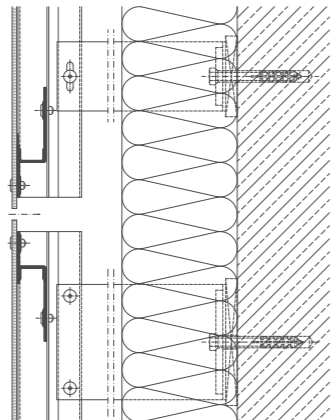
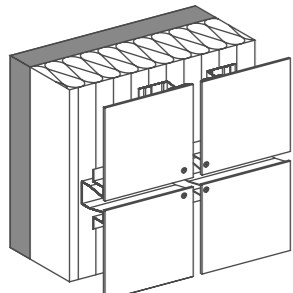

FIXING SYSTEMS.

SCHOOL OF MANAGEMENT, SKOLKOVO, MOSCOW, RUSSIA
Adjaye Associates, London, UK

7 CLAMPED / SCREWED onto double hat profiles

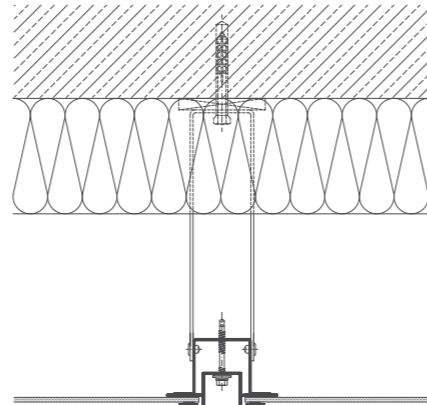
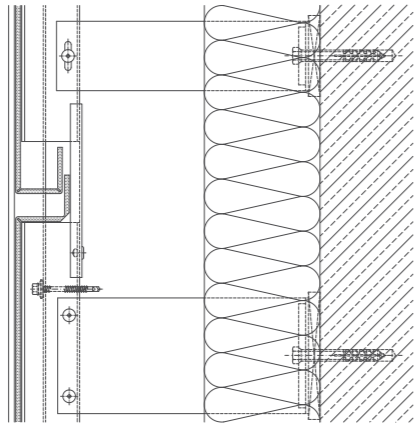
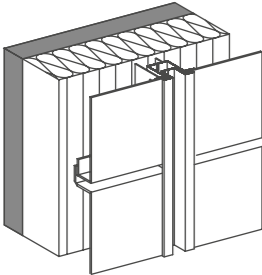

W.A. MARITIME MUSEUM, FREMANTLE, AUSTRALIA
Cox Howlett + Bailey Woodland, Australia

8 RIVETED WEATHER BOARDING on aluminium sub-construction

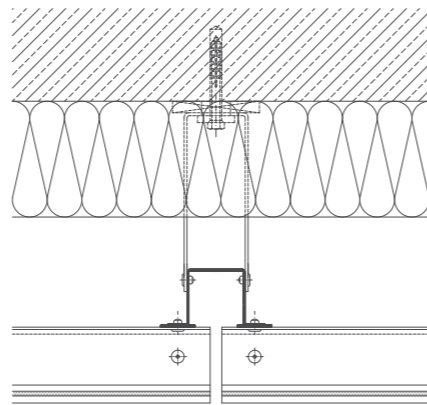
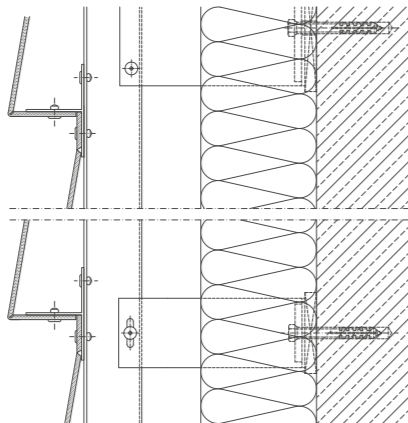
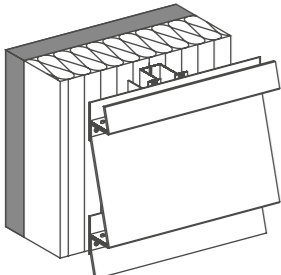

PROTECTION AND SECURITY FOR YOUR BUILDING.



DURABILITY

ALUCOBOND® optimally protects the façade construction against all kinds of weathering and thereby ensures durable, reliable functioning. Resistant to wear and tear, over decades.



HIGHLY ADAPTABLE

With its variety of small or large-format panels and attractive colours and surfaces, ALUCOBOND® opens up a wide range of design possibilities.



FIRE SAFETY

ALUCOBOND® A2 with its mineral core is not combustible, ALUCOBOND® PLUS has low flammability.

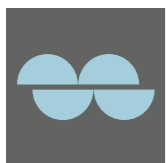

DAMAGE TOLERANCE

The rear-ventilated ALUCOBOND® façade elements are damage tolerant, even when there is extreme expansion, and stay completely flat.

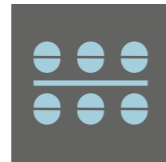

OPTIMAL FLATNESS

The material offers a high level of flexural strength and is extremely lightweight thanks to its sandwich structure. The advantages of the high-quality aluminium alloy (EN AW-5005) are not merely decorative but also offer constructive benefits.



LIGHT WEIGHT

The low weight of ALUCOBOND® is a real advantage when it is mounted and used to renovate existing supporting structures.



GRAFFITI-RESISTANT

Does not give sprayers any chance! Marks can simply be washed off from all standard colours using cleaning agents.



IMPROVED NOISE REDUCTION

Depending on the installation of the rear-ventilated façade, the aluminium composite panel delivers an additional reduction in noise of 8 - 10 dB.

...FOR SUSTAINABLE COMFORT.



ECOLOGICALLY SAFE

ALUCOBOND® composite panels do not at any time in their life cycle release materials endangering the environment. The material is CFC-free and all the paint formulas deployed are free of heavy metals in accordance with RoHS and REACH.



SURE PROTECTION AGAINST DAMPNESS

No condensation and no mould on the walls. The rear ventilation space allows construction water vapour and residential humidity to escape in an orderly manner and also ensures a healthy indoor climate.



SUSTAINABLY ECONOMICAL

ALUCOBOND®- façades provide an extremely cost-effective building envelope with high value retention due to their durability, high functional reliability, freedom from maintenance and economical usage over their entire operational life.

PROTECTIVE FILM

In order to avoid adhesive residues on the surface, caused by UV radiation, the protective foil should be removed as soon as possible after the panels have been installed. Protective foils and panel surfaces are not to be marked with inks (felt tips), adhesive tapes or stickers, as solvents or softeners can damage the painted surfaces. After installation, the protective foil must be removed as quickly as possible, as foils which have been weathered on a long-term basis can only be removed with great difficulty.



RECYCLING

ALUCOBOND® is fully recyclable, i.e. core material and aluminium cover sheets are reintroduced to the material cycle and used in the production of new material.



SAVINGS ON HEATING COSTS

The optimally insulated building envelope provides considerable savings in energy costs. The long-lasting effectiveness of the system guarantees this on an on-going basis.



CERTIFIED ENVIRONMENTAL BALANCE

ALUCOBOND® environmental certification (EPD) is in accordance with international ISO standards. The "environmental footprint" is checked by an independent experts. This document can be downloaded from our website.

STORAGE / HANDLING

ALUCOBOND® is to be protected against rain, dampness penetrating the panels and the build-up of condensation. It is recommended that only panels of the same sized are stacked with a maximum stacking height of 6 pallets. Storage for more than 6 months should be avoided, as the protective foils can become difficult to remove. When stacking panels, do not lay anything between the panels so as to avoid imprints.

ARCHITECTURAL CULTURE AT A GLANCE.



Blunck + Morgen Architekten,
WTM Engineers, Hamburg, (DE)
Bus station Hamburg-Poppenbüttel, (DE)

Page 02; 16-17
ALUCOBOND® Pure white



C.F. Møller Architects,
Aarhus, (DK)
Advice House, Vejle, (DK)

Page 14-15
ALUCOBOND® spectra Cupral



TUM, Emerging Technologies, (DE)
The swarm, Munich, (DE)

Page 30-31
ALUCOBOND® Silver metallic



Renner Hainke Wirth, Architekten (DE)
Cruise Center Altona, Hamburg (DE)

Page 45
ALUCOBOND® anodized look C0/EV1



Pichler & Traupmann Architekten ZT GmbH,
Vienna, (AT)
Raiffeisen Finanz Center, Eisenstadt, (AT)
© paul ott photographed

Page 06-07
ALUCOBOND® Gold metallic



Dominique Perrault Architectes,
Paris, (FR)
"Onix" office building, Lille, (FR)

Page 18-19
ALUCOBOND® naturAL Line



Menig & Partner, Rottendorf, (DE)
S. Oliver Casino new building, (DE)

Page 41
ALUCOBOND® Silver metallic / Black



Stadtbildplanung
Dortmund GmbH, (DE)
Höxterstrasse, Hagen, (DE)

Page 45
ALUCOBOND® different colours



Henning Larsen Architects,
Kopenhagen, (DK)
Concert and congress hall, Uppsala, (SE)
© Åke E Lindmann photographed

Page 08-09; 41
ALUCOBOND® Sunrise Silver metallic



Pascall + Watson Architects,
London, (UK)
Dublin Airport Terminal 2,
Dublin, (IE)

Page 20-21
ALUCOBOND® Silver metallic/
Traffic grey



Hermann Eisenköck Architects,
Graz, (AT)
IMF Tertia, Lannach, (AT)

Page 43
ALUCOBOND® Black



Cos Howlett + Bailey Woodland, (AU)
W.A. Maritime Museum,
Fremantle, (AU)

Page 47
ALUCOBOND® Traffic White/Sunrise
Silver metallic



Adjaye Associates, London, (UK)
School of Management, Moscow (RU)

Page 10-11; 47
ALUCOBOND® different colours



Zimmermann Architectural
Cooperative (DE)
Student Residence, Dresden, (DE)

Page 22-23
ALUCOBOND® Silver metallic,
Smoke silver metallic,
Sparkling red metallic



Hank + Hirth, Ehningen, (DE)
Marc Cain Administrative
Head Office, Bodelshausen, (DE)

Page 12-13; 43
ALUCOBOND® Pure white



Shigeru Ban and Jean de Gastines,
Paris, (FR)
Centre Pompidou, Metz, (FR)
© Hufton + Crow/View/and
Roland Halbe/Artur Images

Page 24-25
ALUCOBOND® Pure white

Create the difference.

ALUCOBOND®



3A Composites GmbH
Alusingenplatz 1
78224 Singen, Germany
Tel +49 7731 - 941 2347
info.eu@alucobond.com
www.alucobond.com

